

ウルトラファイブ

カートリッジヒーター（ミリサイズ、インチサイズ）



特注品も製作可能です

特長

- 1. 高効率：**
研究されつくした高精度な製品で、ロスなく熱をつたえます。
- 2. 長寿命：**
発熱線にハイニッケル合金を使用し、当社独自の耐熱絶縁マグネシアを使用しているため、従来品に比べ著しく長寿命を保てます。
- 3. 堅牢性：**
使用中に発生する機械的振動や衝撃に耐えうる設計で、長期のテストに合格した堅牢な構造です。
- 4. 電気特性：**
電気絶縁性に優れ、高温時は特に安定した絶縁性能を保持します。
- 5. 豊富な種類：**
ミリサイズ、インチサイズの豊富な種類で、お客様のニーズにお応えします。

カートリッジヒーター「ウルトラファイブ」は、当社の長年にわたるシーズヒーターの、製造技術と品質管理を生かした、信頼のおける製品です。このヒーター製造技術により、国産人工衛星用ヒーターを開発し、宇宙開発用共通部品として認定されました。連日フル稼働が必要とされる、熱板・金型などの加熱には、使用中のトラブルは許されません。また、安定した電気絶縁のもと、発生させたヒーター内部の熱を速やかに外部に伝達させ、しかも機械的ショックにも堅牢でなければなりません。「ウルトラファイブ」は、これらの諸問題を解決しました。長期の安定した機械の稼働をお約束します。

使用上のご注意

カートリッジヒーターでは、ヒーターから加熱される金属への、熱伝達を良くすることが重要です。

- 挿入する穴径と、ヒーター径の差は極力小さくしてください。（0.1 mm以下：φ10 ヒーターなら φ10.1 穴）
- 穴の内面は平滑に仕上げてください。リーマ加工をお奨めします。
- 穴加工に使用したオイルは除去してください。オイルが残っていると、オイルが加熱され炭化物となり、熱伝導が悪くなります。
- 定格電圧以下でのご使用は、全く問題ありません。この時の容量は次のように計算してください。

$$\left[\frac{\text{使用電圧}}{\text{定格電圧}} \right]^2 \times \text{定格容量} = \text{使用時の容量}$$

（例）120V 500W のヒーターを、100V でご使用の場合は、347W となります。

- 可動部に HL 型・インチサイズを使用する場合は、端末部特殊仕様（P2-14）をおすすめします。
- 構造上、保管時・長時間使用停止したときに絶縁性能が低下します。使用条件により、低下が問題になる場合は、ニューウルトラファイブ（P2-12）、ガラスシールカートリッジヒーター（P2-17）をお選びください。

金型材質別 金型温度-ヒーター最大容量密度の目安

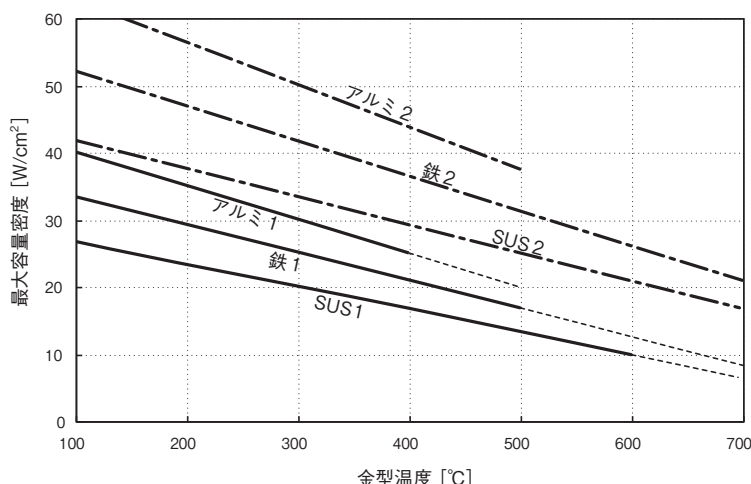

《材質の後の数字》

1：長時間使用する場合（95%信頼度で、20,000時間）

2：短時間使用する場合（平均寿命で、1,000時間）

- 挿入する穴径が、ヒーター径+0.1mm（φ10ヒーターならφ10.1穴）の場合です。穴径が大いだと、ヒーターから金型への熱伝達率が低下し、寿命が短くなります。
- 使用条件・ヒーター仕様の違いにより、寿命時間は変わります。
- 寿命時間を保証するものではありません。目安としてください。
- インチサイズカートリッジヒーターを、100V（120V用）、200V（240V用）で使用する場合、容量および容量密度は、約70%になります。
- 可動部に使用した場合の、電線部分などの損傷による寿命は考慮していません。

HL 型

シース径 $\phi 2.3$

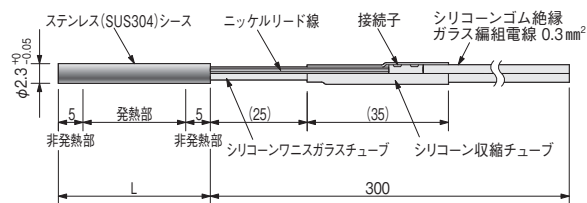

耐電圧：AC500V 1分

WD：発熱部表面容量密度 (W/cm²)

在庫	型番	商品コード	電圧	容量 (W)	L寸法 (mm)	WD
◎	HLY0051	03080140	12V	5	15	14
◎	HLY0102	03080145	24V	10	20	
◎	HLY1203	03080150	100V	20	30	
◎	HLY1354	03080155		35	50	
◎	HLY1605	03080160		60	80	
◎	HLY1806	03080165		80	100	

12V / 24V 仕様のヒーターには、P17-6 のトランスが使用できます。

シース径 $\phi 3.1$

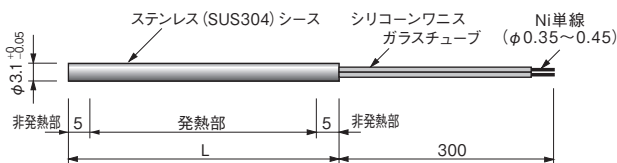

耐電圧：AC600V 1分

WD：発熱部表面容量密度 (W/cm²)

在庫	型番	商品コード	電圧	容量 (W)	L寸法 (mm)	WD
	HLJ0081	03089410	24V	8	25	5.5
	HLJ0152	03089420		15	50	3.9
	HLJ0203	03089430		20	75	3.2

24V 仕様のヒーターには、P17-6 のトランスが使用できます。

シース径 $\phi 4.0$

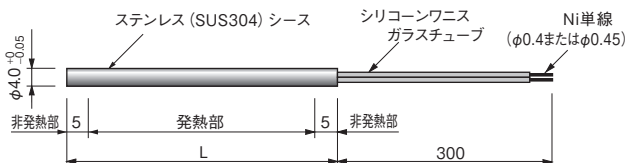

耐電圧：AC600V 1分

WD：発熱部表面容量密度 (W/cm²)

在庫	型番	商品コード	電圧	容量 (W)	L寸法 (mm)	WD
	HLW0011	03089440	24V	10	25	5.3
	HLW0025	03089450		20	50	4.0
	HLW0036	03089460		30	75	3.8
◎	HLW1021	03081640	100V	25	25	13
◎	HLW1032	03081650		30	30	12
◎	HLW1033	03081660		35	35	11
◎	HLW1044	03081670		45	40	12
◎	HLW1065	03081680		60	50	
◎	HLW1106	03081690		100	80	11
◎	HLW1127	03081700		120	100	
◎	HLW2044	03082670	単相 200V	45	40	12
◎	HLW2065	03082680		60	50	
◎	HLW2106	03082690		100	80	11
◎	HLW2127	03082700		120	100	

24V 仕様のヒーターには、P17-6 のトランスが使用できます。

WD：発熱部表面容量密度 (W/cm²)

HL型 シース径 φ6.0～φ14.0

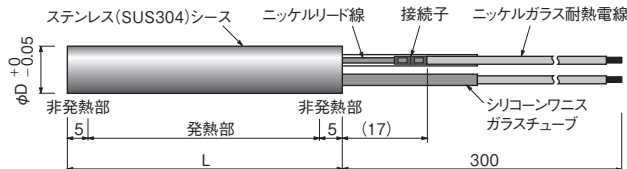

24V 用		電線断面積		1.25 mm ²		
在庫	型番	商品コード	寸法 (mm)		容量 (W)	WD
			D	L		
	HLX0052	03089470	6.0	50	50	6.6
	HLX0103	03089480		100	100	5.9
	HLX0154	03089490		150	150	5.7
	HLB0051	03089500	6.5	50	50	6.1
	HLB0103	03089510		100	100	5.4
	HLB0154	03089520		150	150	5.3
	HLC0061	03089530	8.0	50	60	6.0
	HLC0123	03089540		100	120	4.8
	HLC0185	03089550		150	180	5.1
	HLE0101	03089560	10.0	50	100	8.0
	HLE0153	03089570		100	150	5.3
	HLE0205	03089580		150	200	4.5

24V 仕様のヒーターには、P17-6 のトランスが使用できます。

100V 用 (続き)		容量		~1000W	~1400W	~1500W	
在庫	型番	商品コード	電線断面積		1.25 mm ²	2 mm ²	3.5 mm ²
			D	L	容量 (W)	WD	
	HLD1305	03081890	9.42 (3/8インチ)	150	300	7.2	
	HLD1505	03081900			500	12	
◎	HLE1101	03081210	10.0	50	100	8.0	
◎	HLE1201	03081220			200	16	
◎	HLE1152	03081230		80	150	6.8	
◎	HLE1252	03081240			250	11	
◎	HLE1203	03081250		100	200	7.1	
◎	HLE1303	03081260			300	11	
◎	HLE1204	03081270			200	5.3	
◎	HLE1404	03081280		130	400	11	
◎	HLE1305	03081290			300	6.8	
◎	HLE1505	03081300		150	500	11	
◎	HLE1406	03080210			400	7.5	
◎	HLE1656	03080220		180	650	12	
◎	HLE1457	03080230			450	7.5	
◎	HLE1707	03080240		200	700	12	
◎	HLE1558	03080250			550	8	
◎	HLE1808	03080260		230	800	12	
◎	HLE1609	03080270			600	8	
◎	HLE1909	03080280		250	900	12	
◎	HLF3701	03080290			700	7.7	
◎	HLF3101	03080300		300	1000	11	
◎	HLF1101	03081310	100		6.6		
◎	HLF1201	03081320	50	200	13		
◎	HLF1202	03081330		200	7.6		
◎	HLF1302	03081340	80	300	11		
◎	HLF1253	03081350		250	7.4		
◎	HLF1403	03081360	100	400	12		
◎	HLF1304	03081370		300	6.6		
◎	HLF1504	03081380	130	500	11		
◎	HLF1405	03081390		400	7.6		
◎	HLF1605	03081400	150	600	11		
◎	HLF1506	03081410		500	7.4		
◎	HLF1806	03081420	190	800	12		
◎	HLF1557	03080310		550	7.7		
◎	HLF1857	03080320	200	850	12		
◎	HLF1708	03080330		700	8.4		
◎	HLF1108	03080340	230	1000	12		
◎	HLF1709	03080350		700	7.7		
◎	HLF1109	03080360	250	1050	12		
◎	HLF3851	03080370		850	7.8		
◎	HLF3131	03080380	300	1300	12		
	HLD1101	03081910		100	6.3		
	HLD1201	03081920	50	200	13		
	HLD1202	03081930		200	7.2		
	HLD1302	03081940	80	300	11		
	HLD1253	03081950		250	7		
	HLD1403	03081960	100	400	11		
	HLD1304	03081970		300	6.3		
	HLD1504	03081980	130	500	11		
	HLD1405	03081990		400	7.2		
	HLD1605	03081991	150	600	11		
	HLD1506	03081992		500	7		
	HLD1806	03081993	190	800	11		
◎	HLH1101	03081510		100	5.7		
◎	HLH1201	03081520	50	200	11		
◎	HLH1202	03081530		200	6.5		
◎	HLH1302	03081540	80	300	9.7		
◎	HLH1253	03081550		250	6.3		
◎	HLH1453	03081560	100	450	11		
◎	HLH1354	03081570		350	6.6		
◎	HLH1554	03081580	130	550	10		

100V 用		容量		~1000W	~1400W	~1500W	
在庫	型番	商品コード	電線断面積		1.25 mm ²	2 mm ²	3.5 mm ²
			D	L	容量 (W)	WD	
◎	HLX1101	03081770	6.0	35	50	11	
◎	HLX1152	03081780		50	100	13	
◎	HLX1103	03081790		80	150	11	
◎	HLX1203	03081800		100	200	12	
	HLA1101	03081720	6.25 (1/4インチ)	50	100	13	
	HLA1102	03081730		80	100	7.3	
	HLA1152	03081740		150	11		
	HLA1103	03081750		100	100	5.7	
	HLA1203	03081760	6.5	100	200	11	
◎	HLB1101	03081020		50	100	12	
◎	HLB1102	03081030	80	100	7.0		
◎	HLB1152	03081040		150	10		
◎	HLB1103	03081050	100	100	5.4		
◎	HLB1203	03081060		200	11		
◎	HLC1101	03081110	8.0	50	100	9.9	
◎	HLC1151	03081120		150	15		
◎	HLC1102	03081130		80	100	5.7	
◎	HLC1202	03081140			200	11	
◎	HLC1153	03081150		100	150	6.6	
◎	HLC1253	03081160			250	11	
◎	HLC1204	03081170		130	200	6.6	
◎	HLC1304	03081180			300	9.9	
◎	HLC1305	03080010		150	300	8.5	
◎	HLC1455	03080020			450	13	
◎	HLC1356	03080030		180	350	8.2	
◎	HLC1506	03080040			500	12	
◎	HLC1407	03080050		200	400	8.4	
◎	HLC1607	03080060			600	13	
◎	HLC1458	03080070		230	450	8.1	
◎	HLC1658	03080080			650	12	
◎	HLC1509	03080090	250	500	8.3		
◎	HLC1709	03080100		700	12		
◎	HLC3551	03080110	300	550	7.5		
◎	HLC3851	03080120		850	12		
	HLD1101	03081810	9.42 (3/8インチ)	50	100	8.4	
	HLD1201	03081820		200	17		
	HLD1152	03081830		80	150	7.2	
	HLD1252	03081840			250	12	
	HLD1203	03081850		100	200	7.5	
	HLD1303	03081860			300	11	
	HLD1204	03081870		130	200	5.6	
	HLD1404	03081880			400	11	

○：【短納期品】 通常2~5営業日で出荷できます (在庫切れの場合もあります)

無印：【受注生産品】 納期についてはお問い合わせください

工 金型加熱
 工 ノズル加熱
 工 均熱加熱
 工 熱風工具
 工 遠赤外線
 工 凝固防止
 工 凍結防止
 工 霜取り工具
 工 熱切断
 工 水加熱
 工 油薬液海水
 工 洗浄液
 工 暖房・加温
 工 温度制御
 工 温度検知
 工 オレンジ部品
 工 特別設計品
 工 技術資料

100V用 (続き)		容量	~1000W	~1400W	~1500W	
		電線断面積	1.25 mm ²	2 mm ²	3.5 mm ²	
在庫	型番	商品コード	寸法 (mm)		容量 (W)	WD
			D	L		
◎	HLH1405	03081590	14.0	150	400	6.5
◎	HLH1705	03081600			700	11
◎	HLH1556	03081610		550	6.9	
◎	HLH1906	03081620		900	11	
◎	HLH1657	03080410		650	7.8	
◎	HLH1107	03080420		1000	12	
◎	HLH1758	03080430		750	7.8	
◎	HLH1118	03080440		1150	12	
◎	HLH1809	03080450		800	7.6	
◎	HLH1129	03080460		1250	12	
◎	HLH3101	03080470	1000	7.8		
◎	HLH3151	03080480	1500	12		

単相 200V用		電線断面積		1.25 mm ²		
在庫	型番	商品コード	寸法 (mm)		容量 (W)	WD
			D	L		
◎	HLX2101	03082770	6.0	35	50	11
◎	HLX2152	03082780		50	100	13
◎	HLX2103	03082790		80	150	11
◎	HLX2203	03082800		100	200	12
	HLA2101	03082720	6.25 (1/4インチ)	50	100	13
	HLA2102	03082730		80	100	7.3
	HLA2152	03082740		150	11	
	HLA2103	03082750	100	100	5.7	
	HLA2203	03082760		200	11	
◎	HLB2101	03082020	6.5	50	100	12
◎	HLB2102	03082030		80	100	7.0
◎	HLB2152	03082040		150	10	
◎	HLB2103	03082050		100	5.4	
◎	HLB2203	03082060	200	11		
◎	HLC2101	03082110	8.0	50	100	9.9
◎	HLC2151	03082120		150	15	
◎	HLC2102	03082130		100	5.7	
◎	HLC2202	03082140		80	200	11
◎	HLC2153	03082150		100	150	6.6
◎	HLC2253	03082160		250	11	
◎	HLC2204	03082170		130	200	6.6
◎	HLC2304	03082180		300	9.9	
◎	HLC2305	03080510		150	300	8.5
◎	HLC2455	03080520		450	13	
◎	HLC2356	03080530	180	350	8.2	
◎	HLC2506	03080540		500	12	
◎	HLC2407	03080550	200	400	8.4	
◎	HLC2607	03080560		600	13	
◎	HLC2458	03080570		450	8.1	
◎	HLC2658	03080580	230	650	12	
◎	HLC2509	03080590		500	8.3	
◎	HLC2709	03080600	250	700	12	
◎	HLC4551	03080610		550	7.5	
◎	HLC4851	03080620	300	850	12	
◎	HLD2101	03082810		100	8.4	
◎	HLD2201	03082820		200	17	
	HLD2152	03082830	80	150	7.2	
	HLD2252	03082840		250	12	
	HLD2203	03082850		200	7.5	
	HLD2303	03082860	100	300	11	
	HLD2204	03082870		200	5.6	
	HLD2404	03082880	130	400	11	
	HLD2305	03082890		300	7.2	
	HLD2505	03082900	150	500	12	
◎	HLE2101	03082210		10.0	100	8.0
◎	HLE2201	03082220	200		16	
◎	HLE2152	03082230	150		6.8	
◎	HLE2252	03082240	250		11	

単相 200V用 (続き)			電線断面積		1.25 mm ²	
在庫	型番	商品コード	寸法 (mm)		容量 (W)	WD
			D	L		
◎	HLE2203	03082250	10.0	100	200	7.1
◎	HLE2303	03082260			300	11
◎	HLE2204	03082270		200	5.3	
◎	HLE2404	03082280		130	400	11
◎	HLE2305	03082290			300	6.8
◎	HLE2505	03082300		150	500	11
◎	HLE2406	03080710			400	7.5
◎	HLE2656	03080720		180	650	12
◎	HLE2457	03080730			450	7.5
◎	HLE2707	03080740		200	700	12
◎	HLE2558	03080750	550		8.0	
◎	HLE2808	03080760	230	800	12	
◎	HLE2609	03080770		600	8.0	
◎	HLE2909	03080780	250	900	12	
◎	HLE4701	03080790		700	7.7	
◎	HLE4101	03080800	300	1000	11	
◎	HLF2101	03082310		100	6.6	
◎	HLF2201	03082320	50	200	13	
◎	HLF2202	03082330		200	7.6	
◎	HLF2302	03082340	80	300	11	
◎	HLF2253	03082350		250	7.4	
◎	HLF2403	03082360	100	400	12	
◎	HLF2304	03082370		300	6.6	
◎	HLF2504	03082380	130	500	11	
◎	HLF2405	03082390		400	7.6	
◎	HLF2605	03082400	150	600	11	
◎	HLF2506	03082410		500	7.4	
◎	HLF2806	03082420	190	800	12	
◎	HLF2557	03080810		550	7.7	
◎	HLF2857	03080820	200	850	12	
◎	HLF2708	03080830		700	8.4	
◎	HLF2108	03080840	230	1000	12	
◎	HLF2709	03080850		700	7.7	
◎	HLF2109	03080860	250	1050	12	
◎	HLF4851	03080870		850	7.8	
◎	HLF4131	03080880	300	1300	12	
	HLG2101	03082910		100	6.3	
	HLG2201	03082920	50	200	13	
	HLG2202	03082930		200	7.2	
	HLG2302	03082940	80	300	11	
	HLG2253	03082950		250	7.0	
	HLG2403	03082960	100	400	11	
	HLG2304	03082970		300	6.3	
	HLG2504	03082980	130	500	11	
	HLG2405	03082990		400	7.2	
	HLG2605	03082991	150	600	11	
	HLG2506	03082992		500	7.0	
	HLG2806	03082993	190	800	11	
◎	HLH2101	03082510		50	100	5.7
◎	HLH2201	03082520	200		11	
◎	HLH2202	03082530	80	200	6.5	
◎	HLH2302	03082540		300	9.7	
◎	HLH2253	03082550	100	250	6.3	
◎	HLH2453	03082560		450	11	
◎	HLH2354	03082570	130	350	6.6	
◎	HLH2554	03082580		550	10	
◎	HLH2405	03082590	150	400	6.5	
◎	HLH2705	03082600		700	11	
◎	HLH2556	03082610	190	550	6.9	
◎	HLH2906	03082620		900	11	
◎	HLH2657	03080910	200	650	7.8	
◎	HLH2107	03080920		1000	12	
◎	HLH2758	03080930	230	750	7.8	
◎	HLH2118	03080940		1150	12	
◎	HLH2809	03080950	250	800	7.6	
◎	HLH2129	03080960		1250	12	
◎	HLH4101	03080970	300	1000	7.8	
◎	HLH4151	03080980		1500	12	

WD：発熱部表面容量密度 (W/cm²)

HL型 シース径 φ15.0～φ20.0

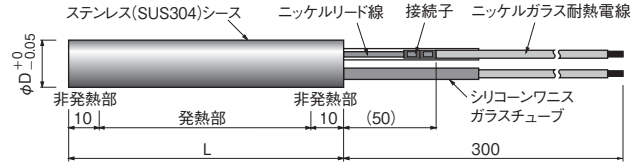

100V用		容量	～1000W	～1400W	～1800W	～2200W
		電線断面積	1.25mm ²	2mm ²	3.5mm ²	5.5mm ²
在庫	型番	商品コード	寸法 (mm)		容量 (W)	WD
			D	L		
15.0	HLQ1151	03087710	50		150	11
	HLQ1291	03087720			200	14
	HLQ1252	03087730	80		250	8.8
	HLQ1402	03087740			400	14
	HLQ1353	03087750	100		350	9.3
	HLQ1503	03087760			500	13
	HLQ1454	03087770	130		450	8.7
	HLQ1654	03087780			650	13
	HLQ1555	03087790	150		550	9.0
	HLQ1805	03087800			800	13
	HLQ1656	03087810	180		650	8.6
	HLQ1956	03087820			950	13
	HLQ1707	03087830	200		700	8.3
	HLQ1107	03087840			1050	12
	HLQ1858	03087850	230		850	8.6
	HLQ1128	03087860			1250	13
	HLQ1909	03087870	250		900	8.3
	HLQ1139	03087880			1350	12
	HLQ3101	03087890	300		1050	8.0
	HLQ3161	03087900			1600	12
16.0	HLR1151	03087910	50		150	9.9
	HLR1251	03087920			250	17
	HLR1252	03087930	80		250	8.3
	HLR1402	03087940			400	13
	HLR1353	03087950	100		350	8.7
	HLR1553	03087960			550	14
	HLR1404	03087970	130		400	7.2
	HLR1704	03087980			700	13
	HLR1555	03087990	150		550	8.4
	HLR1855	03088000			850	13
	HLR1656	03088010	180		650	8.1
	HLR1956	03088020			950	12
	HLR1757	03088030	200		750	8.3
	HLR1117	03088040			1150	13
	HLR1908	03088050	230		900	8.5
	HLR1138	03088060			1300	12
	HLR1959	03088070	250		950	8.2
	HLR1149	03088080			1450	13
	HLR3111	03088090	300		1150	8.2
	HLR3171	03088100			1750	12
18.0	HLS1151	03088110	50		150	8.8
	HLS1251	03088120			250	15
	HLS1302	03088130	80		300	8.8
	HLS1452	03088140			450	13
	HLS1403	03088150	100		400	8.8
	HLS1603	03088160			600	13
	HLS1554	03088170	130		550	8.8
	HLS1804	03088180			800	13
	HLS1605	03088190	150		600	8.2
	HLS1955	03088200			950	13
	HLS1756	03088210	180		750	8.3
	HLS1116	03088220			1150	13
	HLS1857	03088230	200		850	8.4
	HLS1137	03088240			1300	13
	HLS1108	03088250	230		1000	8.4
	HLS1158	03088260			1500	13
	HLS1109	03088270	250		1050	8.1
	HLS1169	03088280			1600	12
	HLS3131	03088290	300		1300	8.2
	HLS3191	03088300			1950	12

100V用 (続き)		容量	～1000W	～1400W	～1800W	～2200W
		電線断面積	1.25mm ²	2mm ²	3.5mm ²	5.5mm ²
在庫	型番	商品コード	寸法 (mm)		容量 (W)	WD
			D	L		
20.0	HLT1201	03088310	50		200	11
	HLT1301	03088320			300	16
	HLT1352	03088330	80		350	9.3
	HLT1502	03088340			500	13
	HLT1453	03088350	100		450	9.0
	HLT1653	03088360			650	13
	HLT1604	03088370	130		600	8.7
	HLT1904	03088380			900	13
	HLT1705	03088390	150		700	8.6
	HLT1105	03088400			1050	13
	HLT1856	03088410	180		850	8.5
	HLT1126	03088420			1250	12
	HLT1957	03088430	200		950	8.4
	HLT1147	03088440			1400	12
	HLT1118	03088450	230		1100	8.3
	HLT1168	03088460			1650	13
	HLT1129	03088470	250		1200	8.3
	HLT1189	03088480			1800	12
	HLT3141	03088490	300		1450	8.2
	HLT3221	03088500			2200	13

単相 200V用		容量	～2000W	～2200W		
		電線断面積	1.25mm ²	2mm ²		
在庫	型番	商品コード	寸法 (mm)		容量 (W)	WD
			D	L		
15.0	HLQ2151	03088510	50		150	11
	HLQ2291	03088520			200	14
	HLQ2252	03088530	80		250	8.8
	HLQ2402	03088540			400	14
	HLQ2353	03088550	100		350	9.3
	HLQ2503	03088560			500	13
	HLQ2454	03088570	130		450	8.7
	HLQ2654	03088580			650	13
	HLQ2555	03088590	150		550	9.0
	HLQ2805	03088600			800	13
	HLQ2656	03088610	180		650	8.6
	HLQ2956	03088620			950	13
	HLQ2707	03088630	200		700	8.3
	HLQ2107	03088640			1050	12
	HLQ2858	03088650	230		850	8.6
	HLQ2128	03088660			1250	13
	HLQ2909	03088670	250		900	8.3
	HLQ2139	03088680			1350	12
	HLQ4101	03088690	300		1050	8.0
	HLQ4161	03088700			1600	12
16.0	HLR2151	03088710	50		150	9.9
	HLR2251	03088720			250	17
	HLR2252	03088730	80		250	8.3
	HLR2402	03088740			400	13
	HLR2353	03088750	100		350	8.7
	HLR2553	03088760			550	14
	HLR2404	03088770	130		400	7.2
	HLR2704	03088780			700	13
	HLR2555	03088790	150		550	8.4
	HLR2855	03088800			850	13
	HLR2656	03088810	180		650	8.1
	HLR2956	03088820			950	12
	HLR2757	03088830	200		750	8.3
	HLR2117	03088840			1150	13

金型加熱
ノズル加熱
均熱加熱
熱風工具
遠赤外線
凝固防止
凍結防止
結露防止
熱切断
水加熱
油薬液海水
洗浄液
暖房・加温
温度制御
温度検知
熱工器具用
設計品別
技術資料

WD：発熱部表面容量密度 (W/cm²)

単相 200V 用 (続き)			容量		~2000W	~2200W	
			電線断面積		1.25mm ²	2mm ²	
在庫	型番	商品コード	寸法 (mm)		容量 (W)	WD	
			D	L			
	HLR2908	03088850	16.0	230	900	8.5	
	HLR2138	03088860			1300	12	
	HLR2959	03088870			250	950	8.2
	HLR2149	03088880				1450	13
	HLR4111	03088890	300	1150	8.2		
	HLR4171	03088900			1750	12	
	HLS2151	03088910	18.0	50	150	8.8	
	HLS2251	03088920			250	15	
	HLS2302	03088930		80	300	8.8	
	HLS2452	03088940			450	13	
	HLS2403	03088950		100	400	8.8	
	HLS2603	03088960			600	13	
	HLS2554	03088970		130	550	8.8	
	HLS2804	03088980			800	13	
	HLS2605	03088990		150	600	8.2	
	HLS2955	03089000			950	13	
	HLS2756	03089010		180	750	8.3	
	HLS2116	03089020			1150	13	
	HLS2857	03089030	200	850	8.4		
	HLS2137	03089040		1300	13		
	HLS2108	03089050	230	1000	8.4		
	HLS2158	03089060		1500	13		
	HLS2109	03089070	250	1050	8.1		
	HLS2169	03089080		1600	12		

単相 200V 用 (続き)			容量		~2000W	~2200W
			電線断面積		1.25mm ²	2mm ²
在庫	型番	商品コード	寸法 (mm)		容量 (W)	WD
			D	L		
	HLS4131	03089090	18.0	300	1300	8.2
	HLS4191	03089100			1950	12
	HLT2201	03089110	20.0	50	200	11
	HLT2301	03089120			300	16
	HLT2352	03089130		80	350	9.3
	HLT2502	03089140			500	13
	HLT2453	03089150		100	450	9.0
	HLT2653	03089160			650	13
	HLT2604	03089170	130	600	8.7	
	HLT2904	03089180		900	13	
	HLT2705	03089190	150	700	8.6	
	HLT2105	03089200		1050	13	
	HLT2856	03089210	180	850	8.5	
	HLT2126	03089220		1250	12	
	HLT2957	03089230	200	950	8.4	
	HLT2147	03089240		1400	12	
	HLT2118	03089250	230	1100	8.3	
	HLT2168	03089260		1650	13	
	HLT2129	03089270	250	1200	8.3	
	HLT2189	03089280		1800	12	
	HLT4141	03089290	300	1450	8.2	
	HLT4221	03089300		2200	13	

SL 型 SL 型は、ガラス繊維被覆ニッケル撚線リードをヒーター内部で接続したものです。

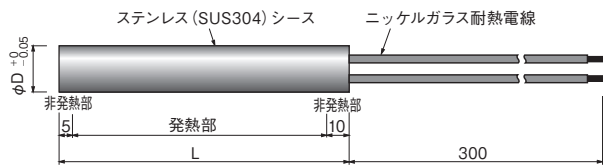

100V 用			寸法 (mm)		容量	WD	
			D	L	(W)		
	SLA1101	03104720	6.25 (1/4インチ)	55	100	13	
	SLA1102	03104730			100	7.3	
	SLA1152	03104740			105	150	11
	SLA1103	03104750				100	5.7
	SLA1203	03104760	6.5 電線断面積 0.5mm ²	55	100	12	
◎	SLB1101	03104020			100	7.0	
◎	SLB1102	03104030		85	150	10	
◎	SLB1152	03104040			100	5.4	
◎	SLB1103	03104050		105	200	11	
◎	SLB1203	03104060			100	9.9	
◎	SLC1101	03104110		8.0 電線断面積 0.75mm ²	55	150	15
◎	SLC1151	03104120				100	5.7
◎	SLC1102	03104130			85	200	11
◎	SLC1202	03104140				150	6.6
◎	SLC1153	03104150		105	250	11	
◎	SLC1253	03104160			200	6.6	
◎	SLC1204	03104170	135	300	9.9		
◎	SLC1304	03104180		300	9.9		
	SLD1101	03104810	9.42 (3/8インチ)	55	100	8.4	
	SLD1201	03104820			200	17	
	SLD1152	03104830		85	150	7.2	
	SLD1252	03104840			250	12	
	SLD1203	03104850		105	200	7.5	
	SLD1303	03104860			300	11	
	SLD1204	03104870	135	200	5.6		
	SLD1404	03104880		400	11		
	SLD1305	03104890		300	7.2		
	SLD1505	03104900	500	12			

100V 用 (続き)			寸法 (mm)		容量	WD
			D	L	(W)	
◎	SLE1101	03104210	10.0 電線断面積 0.75mm ²	55	100	8.0
◎	SLE1201	03104220			200	16
◎	SLE1152	03104230		85	150	6.8
◎	SLE1252	03104240			250	11
◎	SLE1203	03104250		105	200	7.1
◎	SLE1303	03104260			300	11
◎	SLE1204	03104270	135	200	5.3	
◎	SLE1404	03104280		400	11	
◎	SLE1305	03104290	155	300	6.8	
◎	SLE1505	03104300		500	11	
◎	SLF1101	03104310	12.0 電線断面積 1.25mm ²	55	100	6.6
◎	SLF1201	03104320			200	13
◎	SLF1202	03104330		85	200	7.6
◎	SLF1302	03104340			300	11
◎	SLF1253	03104350		105	250	7.4
◎	SLF1403	03104360			400	12
◎	SLF1304	03104370	135	300	6.6	
◎	SLF1504	03104380		500	11	
◎	SLF1405	03104390	155	400	7.6	
◎	SLF1605	03104400		600	11	
◎	SLF1506	03104410	195	500	7.4	
◎	SLF1806	03104420		800	12	
	SLG1101	03104910	12.6 (1/2インチ)	55	100	6.3
	SLG1201	03104920			200	13
	SLG1202	03104930		85	200	7.2
	SLG1302	03104940			300	11
	SLG1253	03104950		105	250	7.0
	SLG1403	03104960			400	11

SL 型 (続き)

100V 用 (続き)

在庫	型番	商品コード	寸法 (mm)		容量 (W)	WD
			D	L		
	SLG1304	03104970	12.6 (1/2インチ) 電線断面積 1.25 mm ²	135	300	6.3
	SLG1504	03104980			500	11
	SLG1405	03104990		155	400	7.2
	SLG1605	03104991			600	11
	SLG1506	03104992		195	500	7.0
	SLG1806	03104993			800	11
	SLH1101	03104510	14.0 電線断面積 1.25 mm ²	55	100	5.7
	SLH1201	03104520			200	11
	SLH1202	03104530		85	200	6.5
	SLH1302	03104540			300	9.7
	SLH1253	03104550		105	250	6.3
	SLH1453	03104560			450	11
	SLH1354	03104570		135	350	6.6
	SLH1554	03104580			550	10
	SLH1405	03104590		155	400	6.5
	SLH1705	03104600			700	11
	SLH1556	03104610		195	550	6.9
	SLH1906	03104620			900	11

単相 200V 用 (続き)

在庫	型番	商品コード	寸法 (mm)		容量 (W)	WD	
			D	L			
◎	SLE2101	03105210	10.0 電線断面積 0.75 mm ²	55	100	8	
◎	SLE2201	03105220			200	16	
◎	SLE2152	03105230		85	150	6.8	
◎	SLE2252	03105240			250	11	
◎	SLE2203	03105250		105	200	7.1	
◎	SLE2303	03105260			300	11	
◎	SLE2204	03105270		135	200	5.3	
◎	SLE2404	03105280			400	11	
◎	SLE2305	03105290		155	300	6.8	
◎	SLE2505	03105300			500	11	
◎	SLE2101	03105310		12.0 電線断面積 1.25 mm ²	55	100	6.6
◎	SLE2201	03105320				200	13
◎	SLE2202	03105330	85		200	7.6	
◎	SLE2302	03105340			300	11	
◎	SLE2253	03105350	105		250	7.4	
◎	SLE2403	03105360			400	12	
◎	SLE2304	03105370	135		300	6.6	
◎	SLE2504	03105380			500	11	
◎	SLE2405	03105390	155		400	7.6	
◎	SLE2605	03105400			600	11	
◎	SLE2506	03105410	195		500	7.4	
◎	SLE2806	03105420			800	12	
	SLG2101	03105910	12.6 (1/2インチ) 電線断面積 1.25 mm ²	55	100	6.3	
	SLG2201	03105920			200	13	
	SLG2202	03105930		85	200	7.2	
	SLG2302	03105940			300	11	
	SLG2253	03105950		105	250	7	
	SLG2403	03105960			400	11	
	SLG2304	03105970		135	300	6.3	
	SLG2504	03105980			500	11	
	SLG2405	03105990		155	400	7.2	
	SLG2605	03105991			600	11	
	SLG2506	03105992		195	500	7	
	SLG2806	03105993			800	11	
	SLH2101	03105510	14.0 電線断面積 1.25 mm ²	55	100	5.7	
	SLH2201	03105520			200	11	
	SLH2202	03105530		85	200	6.5	
	SLH2302	03105540			300	9.7	
	SLH2253	03105550		105	250	6.3	
	SLH2453	03105560			450	11	
	SLH2354	03105570		135	350	6.6	
	SLH2554	03105580			550	10	
	SLH2405	03105590		155	400	6.5	
	SLH2705	03105600			700	11	
	SLH2556	03105610		195	550	6.9	
	SLH2906	03105620			900	11	

単相 200V 用

在庫	型番	商品コード	寸法 (mm)		容量 (W)	WD	
			D	L			
	SLA2101	03105720	6.25 (1/4インチ) 電線断面積 0.5 mm ²	55	100	13	
	SLA2102	03105730		85	100	7.3	
	SLA2152	03105740			150	11	
	SLA2103	03105750		105	100	5.7	
	SLA2203	03105760	200		11		
◎	SLB2101	03105020	6.5 電線断面積 0.5 mm ²	55	100	12	
◎	SLB2102	03105030		85	100	7	
◎	SLB2152	03105040			150	10	
◎	SLB2103	03105050		105	100	5.4	
◎	SLB2203	03105060	200		11		
◎	SLC2101	03105110	8.0 電線断面積 0.75 mm ²	55	100	9.9	
◎	SLC2151	03105120			150	15	
◎	SLC2102	03105130		85	100	5.7	
◎	SLC2202	03105140			200	11	
◎	SLC2153	03105150		105	150	6.6	
◎	SLC2253	03105160			250	11	
◎	SLC2204	03105170		135	200	6.6	
◎	SLC2304	03105180			300	9.9	
	SLD2101	03105810		9.42 (3/8インチ) 電線断面積 0.75 mm ²	55	100	8.4
	SLD2201	03105820				200	17
	SLD2152	03105830			85	150	7.2
	SLD2252	03105840				250	12
	SLD2203	03105850	105		200	7.5	
	SLD2303	03105860			300	11	
	SLD2204	03105870	135		200	5.6	
	SLD2404	03105880			400	11	
	SLD2305	03105890	155		300	7.2	
	SLD2505	03105900			500	12	

● インチサイズ

シース径 φ3.1

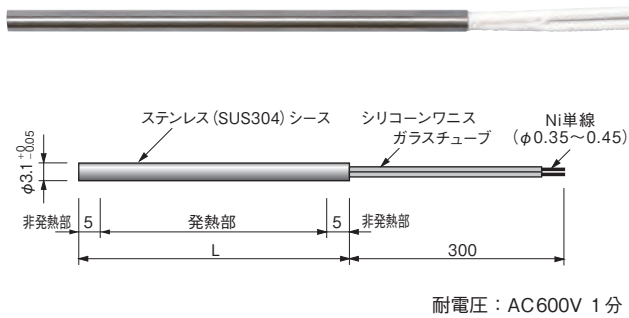

在庫	型番	商品コード	電圧	L寸法 (mm)	容量 (W)	WD
◎	HLJ1021	03083010	120V	31.8	25	12
◎	HLJ1051	03083020			50	24
◎	HLJ1032	03083030		38.1	30	11
◎	HLJ1042	03083040			44	16
◎	HLJ1062	03083050			60	22
◎	HLJ1053	03083060			50.8	50
◎	HLJ1074	03083070	単相 240V	63.5	70	13
◎	HLJ1115	03083080		88.9	110	14
◎	HLJ2042	03085010		38.1	44	16
◎	HLJ2053	03085020		50.8	50	13
◎	HLJ2074	03085030		63.5	70	13
◎	HLJ2115	03085040		88.9	110	14
◎	HLJ2276	03085050	139.7	270	21	

シース径 φ6.25 ~ φ12.60

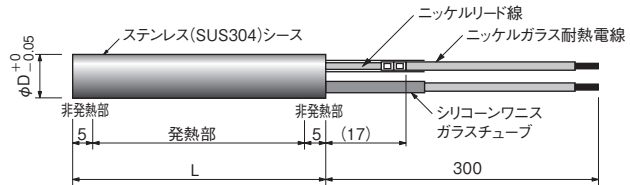

120V用		電線断面積		1.25mm ²		
在庫	型番	商品コード	寸法 D (インチ)	L (mm)	容量 (W)	WD
◎	HLC1081	03083090	1/4 (6.25mm)	25.4	80	26
◎	HLC1101	03083100			100	33
◎	HLC1151	03083110			150	50
◎	HLC1072	03083120		31.8	75	18
◎	HLC1102	03083130			100	23
◎	HLC1152	03083140		38.1	150	35
◎	HLC1053	03083150			50	9.1
◎	HLC1103	03083160			100	18
◎	HLC1153	03083170		50.8	150	27
◎	HLC1203	03083180			200	36
◎	HLC1104	03083190			100	12
◎	HLC1154	03083200		76.2	150	19
◎	HLC1204	03083210	200		25	
◎	HLC1254	03083220	250		31	
◎	HLC1105	03083230	101.6	100	7.7	
◎	HLC1205	03083240		200	15	
◎	HLC1305	03083250		300	23	
◎	HLC1106	03083260	3/8 (9.42mm)	25.4	100	5.6
◎	HLC1206	03083270			200	11
◎	HLC1306	03083280			300	17
◎	HLL1051	03083290	3/8 (9.42mm)	25.4	55	12
◎	HLL1101	03083300			100	22
◎	HLL1151	03083310			150	33
◎	HLL1102	03083320		31.8	100	16
◎	HLL1122	03083330			125	19
◎	HLL1152	03083340			150	23
◎	HLL1202	03083350		38.1	200	31
◎	HLL1053	03083360			50	6.0
◎	HLL1073	03083370			75	9.0
◎	HLL1103	03083380		44.5	100	12
◎	HLL1153	03083390			150	18
◎	HLL1203	03083400			200	24
◎	HLL1253	03083410	101.6	250	30	
◎	HLL1124	03083420		125	12	
◎	HLL1174	03083430		175	17	
◎	HLL1254	03083440	250	24		

120V用 (続き)		電線断面積		1.25mm ²		
在庫	型番	商品コード	寸法 D (インチ)	L (mm)	容量 (W)	WD
◎	HLL1055	03083450	3/8 (9.42mm)	50.8	50	4.1
◎	HLL1105	03083460			100	8.3
◎	HLL1155	03083470			150	12
◎	HLL1205	03083480		57.2	200	17
◎	HLL1255	03083490			250	21
◎	HLL1305	03083500			300	25
◎	HLL1405	03083510		63.5	400	33
◎	HLL1076	03083520			75	5.4
◎	HLL1126	03083530			125	8.9
◎	HLL1176	03083540		76.2	175	13
◎	HLL1256	03083550			250	18
◎	HLL1306	03083560			300	21
◎	HLL1356	03083570	88.9	350	25	
◎	HLL1207	03083580		200	13	
◎	HLL1257	03083590		250	16	
◎	HLL1307	03083600	101.6	300	19	
◎	HLL1407	03083610		400	25	
◎	HLL1507	03083620		500	32	
◎	HLL1108	03083630	114.3	100	5.1	
◎	HLL1158	03083640		150	7.7	
◎	HLL1208	03083650		200	10	
◎	HLL1258	03083660	114.3	250	13	
◎	HLL1308	03083670		300	15	
◎	HLL1408	03083680		400	20	
◎	HLL1508	03083690	114.3	500	26	
◎	HLL1259	03083700		250	11	
◎	HLL1309	03083710		300	13	
◎	HLL1509	03083720	114.3	500	21	
◎	HLL3121	03083730		125	4.6	
◎	HLL3151	03083740		150	5.5	
◎	HLL3251	03083750	114.3	250	9.2	
◎	HLL3301	03083760		300	11	
◎	HLL3401	03083770		400	15	
◎	HLL3501	03083780	114.3	500	18	
◎	HLL3302	03083790		300	9.7	
◎	HLL3502	03083800		500	16	

インチサイズ シース径 $\phi 6.25 \sim \phi 12.60$ (続き)

120V用 (続き)			電線断面積		1.25 mm ²	
在庫	型番	商品コード	寸法		容量 (W)	WD
			D (インチ)	L (mm)		
◎	HLL3153	03083810	3/8 (9.42mm)	127.0	150	4.3
◎	HLL3303	03083820			300	8.7
◎	HLL3503	03083830			500	14
◎	HLL3205	03083840	152.4	127.0	200	4.7
◎	HLL3255	03083850			250	5.9
◎	HLL3405	03083860			400	9.5
◎	HLL3505	03083870	177.8	152.4	500	12
◎	HLL3605	03083880			600	14
◎	HLL3257	03083890			250	5.0
◎	HLL3607	03083900	203.2	177.8	600	12
◎	HLL3309	03083910			300	5.2
◎	HLL3509	03083920			500	8.7
◎	HLL3609	03083930	254.0	203.2	600	10
◎	HLL5402	03083940			400	5.5
◎	HLL5602	03083950			600	8.3
◎	HLL5403	03083960	304.8	254.0	400	4.6
◎	HLL5603	03083970			600	6.9
◎	HLM1051	03083980			50	8.2
◎	HLM1151	03083990	25.4	304.8	150	25
◎	HLM1052	03084000			50	5.8
◎	HLM1122	03084010	31.8	254.0	125	14
◎	HLM1053	03084020			50	4.5
◎	HLM1153	03084030	38.1	304.8	150	13
◎	HLM1203	03084040			200	18
◎	HLM1074	03084050	50.8	38.1	75	4.6
◎	HLM1204	03084060			200	12
◎	HLM1254	03084070			250	15
◎	HLM1304	03084080	57.2	50.8	300	19
◎	HLM1404	03084090			400	25
◎	HLM1075	03084100			75	4.0
◎	HLM1125	03084110	60.3	57.2	125	6.7
◎	HLM1255	03084120			250	13
◎	HLM1405	03084130			400	21
◎	HLM1505	03084140	63.5	60.3	500	27
◎	HLM1106	03084150			100	5.0
◎	HLM1256	03084160			250	13
◎	HLM1506	03084170	69.8	63.5	500	25
◎	HLM1107	03084180			100	4.7
◎	HLM1257	03084190			250	12
◎	HLM1307	03084200	76.2	69.8	300	14
◎	HLM1407	03084210			400	19
◎	HLM1507	03084220			500	24
◎	HLM1408	03084230	88.9	76.2	400	17
◎	HLM1129	03084240			125	4.8
◎	HLM1259	03084250			250	9.5
◎	HLM1309	03084260	101.6	88.9	300	11
◎	HLM1409	03084270			400	15
◎	HLM1509	03084280			500	19
◎	HLM1609	03084290	114.3	101.6	600	23
◎	HLM1759	03084300			750	29
◎	HLM3251	03084310			250	8.0
◎	HLM3501	03084320	127.0	114.3	500	16
◎	HLM3152	03084330			150	4.1
◎	HLM3252	03084340			250	6.9
◎	HLM3302	03084350	127.0	127.0	300	8.3
◎	HLM3352	03084360			350	9.7
◎	HLM3402	03084370			400	11
◎	HLM3502	03084380	114.3	127.0	500	14
◎	HLM3752	03084390			750	21
◎	HLM3503	03084400			500	12
◎	HLM3753	03084410	127.0	114.3	750	18
◎	HLM3204	03084420			200	4.3
◎	HLM3354	03084430			350	7.6
◎	HLM3404	03084440	127.0	127.0	400	8.6
◎	HLM3504	03084450			500	11
◎	HLM3754	03084460			750	16

120V用 (続き)			電線断面積		1.25 mm ²	
在庫	型番	商品コード	寸法		容量 (W)	WD
			D (インチ)	L (mm)		
◎	HLM3505	03084470	1/2 (12.60mm)	139.7	500	9.7
◎	HLM3755	03084480			750	15
◎	HLM3706	03084490			146.0	700
◎	HLM3257	03084500	152.4	139.7	250	4.4
◎	HLM3507	03084510			500	8.9
◎	HLM3757	03084520			750	13
◎	HLM3997	03084530	177.8	152.4	1000	18
◎	HLM3259	03084540			250	3.8
◎	HLM3509	03084550			500	7.5
◎	HLM3609	03084560	203.2	177.8	600	9.0
◎	HLM5302	03084570			300	3.9
◎	HLM5502	03084580			500	6.5
◎	HLM5992	03084590	254.0	203.2	1000	13
◎	HLM5506	03084600			500	5.2
◎	HLM5996	03084610			1000	10
◎	HLM5507	03084620	304.8	254.0	500	4.3
◎	HLM5997	03084630			1000	8.6

単相 240V用			電線断面積		1.25 mm ²		
在庫	型番	商品コード	寸法		容量 (W)	WD	
			D (インチ)	L (mm)			
◎	HLK2222	03085060	1/4 (6.25mm)	31.8	225	53	
◎	HLK2173	03085070			175	32	
◎	HLK2203	03085080			200	36	
◎	HLK2253	03085090	50.8	31.8	250	45	
◎	HLK2124	03085100			125	16	
◎	HLK2154	03085110			150	19	
◎	HLK2204	03085120	60.3	50.8	200	25	
◎	HLK2254	03085130			250	31	
◎	HLK2304	03085140			300	37	
◎	HLK2205	03085150	76.2	60.3	200	15	
◎	HLK2305	03085160			300	23	
◎	HLK2206	03085170			200	11	
◎	HLK2306	03085180	101.6	76.2	300	17	
◎	HLK2357	03085190			127.0	350	15
◎	HLK2408	03085200			152.4	400	14
◎	HLL2201	03085210	31.8	101.6	25.4	200	44
◎	HLL2152	03085220			150	23	
◎	HLL2202	03085230			200	31	
◎	HLL2103	03085240	38.1	101.6	100	12	
◎	HLL2153	03085250			150	18	
◎	HLL2203	03085260			200	24	
◎	HLL2253	03085270	44.5	101.6	250	30	
◎	HLL2254	03085280			250	24	
◎	HLL2105	03085290			100	8.3	
◎	HLL2155	03085300	50.8	101.6	150	12	
◎	HLL2205	03085310			200	17	
◎	HLL2255	03085320			250	21	
◎	HLL2305	03085330	57.2	101.6	300	25	
◎	HLL2405	03085340			400	33	
◎	HLL2126	03085350			125	8.9	
◎	HLL2256	03085360	63.5	101.6	250	18	
◎	HLL2306	03085370			300	21	
◎	HLL2356	03085380			350	25	
◎	HLL2207	03085390	76.2	101.6	200	13	
◎	HLL2257	03085400			250	16	
◎	HLL2307	03085410			300	19	
◎	HLL2407	03085420	127.0	76.2	400	25	
◎	HLL2507	03085430			500	32	
◎	HLL2108	03085440			100	5.1	
◎	HLL2208	03085450	200	10			

工 金型加熱
 工 ノズル加熱
 工 均熱加熱
 工 熱風工具
 工 遠赤外線
 工 凝固防止
 工 凍結防止
 工 結露防止
 工 熱切断
 工 水加熱
 工 油薬液海水
 工 洗浄液
 工 暖房・加湿
 工 温度制御
 工 温度検知
 工 熱工器具用
 設計品
 技術資料

単相 240V 用 (続き)			電線断面積		1.25 mm ²		
在庫	型番	商品コード	寸法		容量 (W)	WD	
			D (インチ)	L (mm)			
◎	HLL2258	03085460	3/8 (9.42mm)	76.2	250	13	
◎	HLL2308	03085470			300	15	
◎	HLL2408	03085480			400	20	
◎	HLL2508	03085490			500	26	
◎	HLL2608	03085500			600	31	
◎	HLL2259	03085510			88.9	250	11
◎	HLL2309	03085520		300		13	
◎	HLL2509	03085530		500		21	
◎	HLL4121	03085540		101.6		125	4.6
◎	HLL4251	03085550				250	9.2
◎	HLL4301	03085560				300	11
◎	HLL4401	03085570			400	15	
◎	HLL4501	03085580	500		18		
◎	HLL4302	03085590	114.3		300	9.7	
◎	HLL4502	03085600		500	16		
◎	HLL4153	03085610		127.0	150	4.3	
◎	HLL4303	03085620			300	8.7	
◎	HLL4503	03085630			500	14	
◎	HLL4753	03085640			750	22	
◎	HLL4993	03085650	1000		29		
◎	HLL4604	03085660	139.7		600	16	
◎	HLL4994	03085670		1000	26		
◎	HLL4255	03085680		152.4	250	5.9	
◎	HLL4405	03085690			400	9.5	
◎	HLL4505	03085700			500	12	
◎	HLL4605	03085710			600	14	
◎	HLL4755	03085720	750		18		
◎	HLL4995	03085730	1000		24		
◎	HLL4606	03085740	165.1	600	13		
◎	HLL4996	03085750		1000	22		
◎	HLL4257	03085760		177.8	250	5.0	
◎	HLL4607	03085770			600	12	
◎	HLL4997	03085780			1000	20	
◎	HLL4608	03085790			190.5	600	11
◎	HLL4998	03085800	1000			19	
◎	HLL4309	03085810	203.2			300	5.2
◎	HLL4509	03085820		500		8.7	
◎	HLL4609	03085830		600		10	
◎	HLL4999	03085840		1000		17	
◎	HLL6601	03085850		241.3	600	8.8	
◎	HLL6991	03085860			1000	15	
◎	HLL6602	03085870	254.0		600	8.3	
◎	HLL6992	03085880			1000	14	
◎	HLL6603	03085890			304.8	600	6.9
◎	HLL6993	03085900				1000	11
◎	HLM2122	03085910		31.8		125	14
◎	HLM2202	03085920				200	23
◎	HLM2153	03085930	38.1			150	13
◎	HLM2203	03085940				200	18
◎	HLM2204	03085950			50.8	200	12
◎	HLM2254	03085960				250	15
◎	HLM2304	03085970		300		19	
◎	HLM2404	03085980		57.2		400	25
◎	HLM2255	03085990	250			13	
◎	HLM2405	03086000	60.3			400	21
◎	HLM2505	03086010			500	27	
◎	HLM2106	03086020			100	5.0	
◎	HLM2256	03086030			63.5	250	13
◎	HLM2506	03086040		500		25	
◎	HLM2107	03086050		100		4.7	
◎	HLM2257	03086060	250	12			
◎	HLM2307	03086070	63.5	300		14	
◎	HLM2407	03086080		400		19	
◎	HLM2507	03086090		500	24		

単相 240V 用 (続き)			電線断面積		1.25 mm ²		
在庫	型番	商品コード	寸法		容量 (W)	WD	
			D (インチ)	L (mm)			
◎	HLM2408	03086100	1/2 (12.60mm)	69.8	400	17	
◎	HLM2129	03086110			125	4.8	
◎	HLM2259	03086120			250	9.5	
◎	HLM2309	03086130			300	11	
◎	HLM2409	03086140			76.2	400	15
◎	HLM2509	03086150				500	19
◎	HLM2609	03086160		600		23	
◎	HLM2759	03086170		750		29	
◎	HLM4251	03086180		88.9		250	8.0
◎	HLM4351	03086190				350	11
◎	HLM4501	03086200			500	16	
◎	HLM4751	03086210			750	24	
◎	HLM4152	03086220	101.6		150	4.1	
◎	HLM4252	03086230			250	6.9	
◎	HLM4302	03086240		300	8.3		
◎	HLM4352	03086250		350	9.7		
◎	HLM4402	03086260		114.3	400	11	
◎	HLM4502	03086270			500	14	
◎	HLM4752	03086280	750		21		
◎	HLM4992	03086290	1000		28		
◎	HLM4503	03086300	127.0		500	12	
◎	HLM4753	03086310			750	18	
◎	HLM4204	03086320		139.7	200	4.3	
◎	HLM4354	03086330			350	7.6	
◎	HLM4404	03086340			400	8.6	
◎	HLM4504	03086350			500	11	
◎	HLM4754	03086360	750		16		
◎	HLM4994	03086370	1000		22		
◎	HLM4505	03086380	146.0	500	9.7		
◎	HLM4755	03086390		750	15		
◎	HLM4706	03086400		152.4	700	13	
◎	HLM4257	03086410			250	4.4	
◎	HLM4507	03086420			500	8.9	
◎	HLM4757	03086430			750	13	
◎	HLM4997	03086440	1000		18		
◎	HLM4508	03086450	165.1		500	8.1	
◎	HLM4998	03086460		1000	16		
◎	HLM4509	03086470		177.8	500	7.5	
◎	HLM4609	03086480			600	9.0	
◎	HLM4999	03086490			1000	15	
◎	HLM6051	03086500			190.5	500	7.0
◎	HLM6101	03086510	1000			14	
◎	HLM6052	03086520	203.2			500	6.5
◎	HLM6102	03086530		1000		13	
◎	HLM6152	03086540		1500		20	
◎	HLM6202	03086550		2000		26	
◎	HLM6053	03086560		215.9	500	6.1	
◎	HLM6103	03086570			1000	12	
◎	HLM6054	03086580	228.6		500	5.8	
◎	HLM6104	03086590			1000	12	
◎	HLM6055	03086600			241.3	500	5.5
◎	HLM6105	03086610				1000	11
◎	HLM6056	03086620		254.0		500	5.2
◎	HLM6106	03086630				1000	10
◎	HLM6156	03086640	304.8			1500	16
◎	HLM6206	03086650				2000	21
◎	HLM6057	03086660			355.6	500	4.3
◎	HLM6107	03086670				1000	8.6
◎	HLM6157	03086680		457.2		1500	13
◎	HLM6207	03086690				2000	17
◎	HLM6108	03086700	1000			7.3	
◎	HLM6238	03086710	2300			17	
◎	HLM6159	03086720	1500		8.5		

WD：発熱部表面容量密度 (W/cm²)

インチサイズ シース径 φ15.77～φ18.95

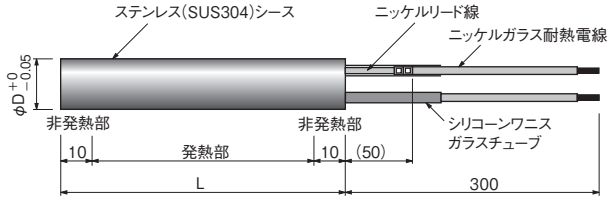
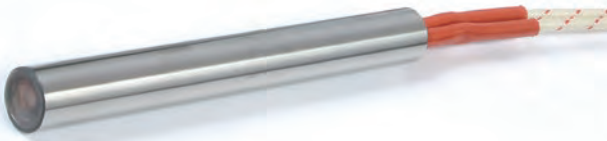

120V用			電線断面積		1.25 mm ²		
在庫	型番	商品コード	寸法		容量 (W)	WD	
			D (インチ)	L (mm)			
	HLN1051	03084640	5/8 (15.77mm)	31.8	50	8.6	
	HLN1201	03084650			200	34	
	HLN1251	03084660			250	43	
	HLN1252	03084670			250	28	
	HLN1103	03084680			50.8	100	6.6
	HLN1203	03084690				200	13
	HLN1104	03084700			57.2	100	5.4
	HLN1254	03084710				250	14
	HLN1354	03084720				350	19
	HLN1285	03084730			60.3	280	14
	HLN1156	03084740		150		5.4	
	HLN1256	03084750		76.2	250	9.0	
	HLN1506	03084760			500	18	
	HLN1527	03084770			95.3	14	
	HLN1258	03084780			101.6	250	6.2
	HLN1259	03084790		127.0	250	4.7	
	HLN3081	03084800			136.5	800	14
	HLN3032	03084810			152.4	300	4.6
	HLN3053	03084820			165.1	500	7.0
	HLN3054	03084830			177.8	500	6.4
	HLN3055	03084840			203.2	500	5.5
	HLN3056	03084850			254.0	500	4.3
	HLN3057	03084860			304.8	500	3.5
	HLN3107	03084870				1000	7.1
	HLP1021	03084880			3/4 (18.95mm)	57.2	200
	HLP1022	03084890		76.2		250	7.5
	HLP1023	03084900		101.6		250	5.1
	HLP1034	03084910		127.0		300	4.7
	HLP1055	03084920		152.4		500	6.3
	HLP1056	03084930		177.8		500	5.3
	HLP1057	03084940		203.2		500	4.6

単相 240V用 (続き)			容量					
在庫	型番	商品コード	電線断面積		～2400W	～3000W	～4000W	～5500W
			1.25 mm ²	2 mm ²	2 mm ²	3.5 mm ²	3.5 mm ²	5.5 mm ²
			寸法		容量 (W)	WD		
			D (インチ)	L (mm)				
	HLN4053	03086980	5/8 (15.77mm)	165.1	500	7.0		
	HLN4054	03086990			500	6.4		
	HLN4104	03087000			177.8	1000	13	
	HLN4154	03087010				1500	19	
	HLN4055	03087020			203.2	500	5.5	
	HLN4085	03087030				850	9.4	
	HLN4105	03087040				1000	11	
	HLN4155	03087050				1500	17	
	HLN4205	03087060				2000	22	
	HLN4056	03087070			254.0	500	4.3	
	HLN4106	03087080		1000		8.6		
	HLN4156	03087090		1500		13		
	HLN4206	03087100		2000		17		
	HLN4057	03087110		304.8 (15.77mm)	500	3.5		
	HLN4107	03087120			1000	7.1		
	HLN4157	03087130			1500	11		
	HLN4207	03087140			2000	14		
	HLN4378	03087150			355.6	3700	22	
	HLN4079	03087160			381.0	750	4.2	
	HLN4249	03087170				2400	13	
	HLN4409	03087180			406.4	4000	22	
	HLN6251	03087190				2500	13	
	HLN6451	03087200			457.2	4500	24	
	HLN6302	03087210		3000		14		
	HLN6472	03087220		508.0	4700	22		
	HLN6153	03087230			1500	6.2		
	HLN6353	03087240			3500	14		
	HLN6473	03087250			4700	19		
	HLN6204	03087260			609.6	2000	6.8	
	HLN6474	03087270				4700	16	
	HLN6305	03087280			914.4	3000	6.8	
	HLP2052	03087290				76.2	500	15
	HLP2053	03087300			101.6	500	10	
	HLP2103	03087310				1000	21	
	HLP2054	03087320		500		7.8		
	HLP2104	03087330		127.0		1000	16	
	HLP2055	03087340		152.4		500	6.3	
	HLP2105	03087350				1000	13	
	HLP2205	03087360		177.8		2000	25	
	HLP2056	03087370				500	5.3	
	HLP2106	03087380	203.2	1000		11		
	HLP2057	03087390		500		4.6		
	HLP2107	03087400	254.0	1000	9.2			
	HLP2207	03087410		2000	18			
	HLP2108	03087420		1000	7.2			
	HLP2208	03087430	304.8 (18.95mm)	2000	14			
	HLP2109	03087440		1000	5.9			
	HLP2209	03087450	355.6	2000	12			
	HLP2409	03087460		4000	24			
	HLP4121	03087470	381.0	1250	6.3			
	HLP4251	03087480		2500	13			
	HLP4451	03087490	406.4	4500	23			
	HLP4152	03087500		1500	7.0			
	HLP4183	03087510	457.2	1800	7.8			
	HLP4473	03087520		4700	20			
	HLP4204	03087530	508.0	2000	7.7			
	HLP4504	03087540		5000	19			
	HLP4115	03087550	580.0	1150	4.0			
	HLP4225	03087560		2250	7.7			
	HLP4525	03087570	609.6	5250	18			
	HLP4136	03087580		1375	3.9			
	HLP4276	03087590	914.4	2750	7.8			
	HLP4556	03087600		5500	16			
	HLP4257	03087610		2500	4.7			

単相 240V用			容量					
在庫	型番	商品コード	電線断面積		～2400W	～3000W	～4000W	～5500W
			1.25 mm ²	2 mm ²	2 mm ²	3.5 mm ²	3.5 mm ²	5.5 mm ²
			寸法		容量 (W)	WD		
			D (インチ)	L (mm)				
	HLN2252	03086730	5/8 (15.77mm)	38.1	250	28		
	HLN2503	03086740			500	33		
	HLN2254	03086750			57.2	250	14	
	HLN2354	03086760				350	19	
	HLN2285	03086770			60.3	280	14	
	HLN2256	03086780				250	9.0	
	HLN2506	03086790				500	18	
	HLN2756	03086800			76.2	750	27	
	HLN2527	03086810				525	14	
	HLN2258	03086820			95.3	250	6.2	
	HLN2408	03086830		400		9.9		
	HLN2508	03086840		101.6		500	12	
	HLN2608	03086850				600	15	
	HLN2758	03086860				750	19	
	HLN2998	03086870		1000		25		
	HLN2259	03086880				250	4.7	
	HLN2509	03086890		127.0		500	9.4	
	HLN2759	03086900				750	14	
	HLN2999	03086910		136.5		1000	19	
	HLN4081	03086920			800	14		
	HLN4032	03086930		152.4	300	4.6		
	HLN4052	03086940			500	7.6		
	HLN4072	03086950			750	11		
	HLN4102	03086960			1000	15		
	HLN4152	03086970			1500	23		